

Hybrid Beaming Forming at 60GHz Radio Millimeter Wave for WPAN

Duncan K. Kilungu

Machakos University/Electrical and Electronics Engineering, Machakos, Kenya

Abstract: This paper represent the concept of hybrid beam forming at 60GHz radio millimeter wave for short range communication WPAN. The result of the proposed model under investigation was varied through various cases. That is the number of antennas on LOS and NLOS on the following beam forming mechanism; symbol wise, hybrid and subcarrier wise. The best performance for the aforementioned schemes under investigation the hybrid gives the best characteristics performance in terms BER and SNR.

Keywords: Beam forming on OFDM-MIMO for short range communication WPAN

1. Introduction

Successful wireless communication transmission solutions in the recent years have been observed in unlicensed bands. Wi-Fi Access Points (AP), radio cables and antennas are now some of the commonly available equipment. Access of unlicensed radio alone stand as the only alternative efficient offer of internet to most of our telecommunication companies which do not provide broadband access in rural areas. In real practice, Wi- networks are important for indoor point to multipoint access and also long distance point to point wireless bridges. However, IEEE 802.11g/n (Wi-Fi) and IEEE802.16m (WiMAX) standards have many limitations with the most significant being the effective throughput for the end-user. Through considering the transmission mode and operation mode of Wi-Fi wireless bridge between the two terminals in an indoor environment, 54Mbps is the maximum physical layer rate, which in comparison to the capacities of the current cable solutions is much less. The provisions of high speed data rates in the recent communication systems plays an important role to people's lives. The connectivity in terms of data rates provisioned by the existing systems is not sufficient for such applications as real time and non- real time application. Personal Area Network (PAN) was designed for the short-range transmission between devices such as mobile phones, TV set box and external microphone sets but does not satisfy the growing throughput/jitter demands.

From the mentioned limitations of the existing systems, there is a need for a wireless solution with higher data rate. 60 GHz band gives a chance of building a new standard for PANs, which allows much higher transfer rates for home application and multimedia application.

The major score of using 60 GHz band is that the radio frequency components are of smaller sizes, leading to the possibility of employing multiple antennas on a small portable device. Considering the hardware cost and the throughput performance, the beam forming (BF) technique is the best choice for the millimeter-wave [1] when compared to the other multiple antenna technologies, like the spatial multiplexing, temporal diversity and spatial diversity.

This paper is organized in the following order Part 1 Introduction were it gives the overview of 60GHz

communication, 2 Literature review, 3 Implementation of hybrid beam forming technology and lastly part 4 which gives the analysis of simulated results BER vs Antenna nodes BER vs LOS and NLOS both on short range communication were the result are drawn for analysis

2. Literature Review

This part gives an overview state of the art in 60GHz beam forming techniques by summarizing the major results from several references and scholarly research related to the model under investigation. It introduces the main concept of multi-antenna techniques and provision for classification, based on the wireless channel characteristics, of the different multiple antenna approaches. The concepts of spatial diversity, fixed and adaptive beam forming are presented under common theoretical definitions are illustrated as we proceed.

Introduction to 60 GHz Wireless communication

Wireless communication has undergone tremendous growth in the commercial sector of industrialization and research organ for example the commercial broadcasting services, global positioning service (GPS), cellular telephony, WLAN, and WPAN technologies. These wireless communications systems are today an integral part of daily life and they continue to improve in quality and user experience. Millimeter wave (mm-wave) technology is one of the recent wireless technologies emerging and it has been defined in IEEE 802.15.3c [4]. Physical layer and medium access under the standard has been addressed. To achieve high data rate in wireless channel several techniques were devised to improve the signal strength [5]. With MIMO-OFDM interfaced together, the diversity is improved and scalability of the available resources is utilized hence achievability of high data rate, high throughput and less traffic delay [6]. An important note is that mm-wave technology has been known for many decades, but its main application has been its deployment for military applications. In the past decade, there has been advancement in the fabrication process and adoption of the hybrid modulation technologies and the less cost integration solutions which have made mm-wave attractive technology to researchers [7].

The 60GHz band of frequency should be exploited so as to alleviate the above problems and also to increase the potential data rates of wireless systems significantly. This gives us the reasons as to why there is increase in the interest to use the unlicensed frequency band around the 60 GHz for short-range communication. This band of frequency has about 7GHz of available bandwidth worldwide. An example is the 57 to 64 GHz band of frequency allocated by United States, and 9GHz bandwidth that is from 57 to 66 GHz which is recommended in Europe.

Wireless systems using this band of frequency have the potential of achieving multiple gigabits per second (Gbps) data rates. By comparing the current WLAN systems having about 150MHz of the available bandwidth, using the 60 GHz band of frequency can provide 10 to 100 times increase in bandwidth hence having a capability of providing the next step into high data rate wireless systems.

2.2 Broadband communication in the 60 GHz frequency band

Significant growth of wireless communication services has been witnessed over the past decade driven by the development of “bandwidth-hungry” and advanced technologies. There has been an evolution in the industry from cell-phones and pagers to personal computers (PCs), set-top-boxes (STB), cutting-edge personal digital assistants (PDAs), and other devices that have the capability of delivering high-speed multimedia content when connected to reliable and fast broadband wireless local area networks (WLAN) and wireless personal area networks (WPAN) [1]. The capacity has been increased by the wireless networks at a pace of ten times in every five years in an attempt to keep up with huge amount of data traffic requirement by the high bit rate.

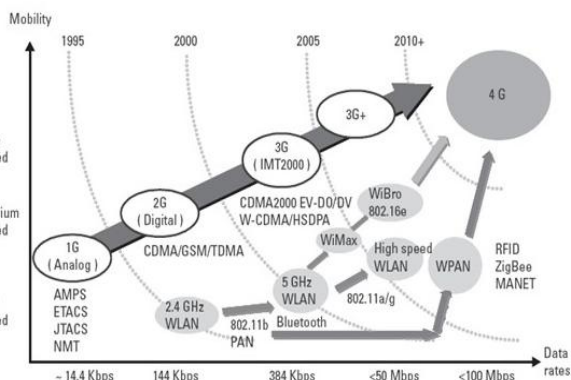

Figure 2.2: Evolution of wireless communication systems

Recent we have large number of applications and services requiring very high data rates in terms of gigabit, and this number is expected to increase rapidly in future. Some of these applications are real-time HD audio/video delivery; high definition television (HDTV) uncompressed streaming, fast file transfers and gaming. These applications currently rely on wired technologies like High Definition Multimedia Interface (HDMI), Fire Wire cables.

2.2.1 Antenna sub system small form factor: As a result of the reduction in the design wavelength (5 mm at 60 GHz), the form-factor of the transceiver antennas is smaller for the

60 GHz system compared to a lower frequency system [6] [13]. The idea of designing large antennas enables a wide variety of the antenna solutions for the radios at 60 GHz that would have been difficult, if even not impossible, at the lower-frequencies.

2.2.2 Front end technology of lower cost: From the various research carried out on the 60 GHz technology the reports formulate how the system model is less cost, highly integrated plus low volume front end technology for the radios at 60 GHz. Complementary metal-oxide semiconductors (CMOS) has been indicated as the only viable solution enabling the development of radios at 60 GHz.

2.3 The drawback for 60 GHz Radio millimeter wave

The band has many challenges which need to be dealt with so as to realize its full capability and capacity. Some of these challenges are as follows:

2.3.1 Poor link budget: Attenuation at 60GHz band is characterized by propagation of the signal. Oxygen-absorption affect short radio-links, free-space path loss that occurs at 60 GHz is in order of 20-30 dB greater than the path loss for WLAN which operates at ISM band, as can readily be determined using the Frii's equation for free-space attenuation. Total noise power is far greater than that of the systems operating at lower frequencies which are as a result of larger transmission bandwidth (2.16GHz). A poor link budget is then as a result of the combination of these factors

2.3.2 Line of sight signal-blockage: The obstruction of the line-of-sight (LOS) signal is another problem of the radios at 60GHz which can occur because of the presence of objects within the propagation path..

2.3.3 Multipath propagation: Signal scattering and reflections e.g. from partitioning of the offices, floors, ceiling, walls, tables, cabinets and presence of human beings are some of the features that are characterized at 60 GHz. Communication at 60 GHz will likely experience the problem of inter-symbol interference (ISI), which may degrade greatly the performance of system if proper counter-measures are not taken. In an indoor environment the main propagation mechanism for 60GHz is line-of-sight (LOS), and when there is a signal blockage (NLOS), the first-order and second-order reflections becomes the propagation mechanism. All the above problems need to be tackled well to obtain the full potential and the delivery of multi gigabit rates of data at 60 GHz technology.

2.4 Comparison with other Unlicensed Systems

In comparison with current communications systems, 60 GHz offers more advantages [1]. Huge unlicensed bandwidth is one of the major reasons that have attracted interest in the 60GHz technology in the recent. Globally, most cooperatives are muscling on the used band that's attract vendors to come up with solutions for solving the un met needs. There is at least availability of 5 GHz continuous bandwidth in many countries and some of them are as shown in Fig.2.4. The 60 GHz is comparable to unlicensed

bandwidth allocated for the ultra-wideband (UWB) purposes though the 60 GHz has a continuous bandwidth with less restrictive power limits.

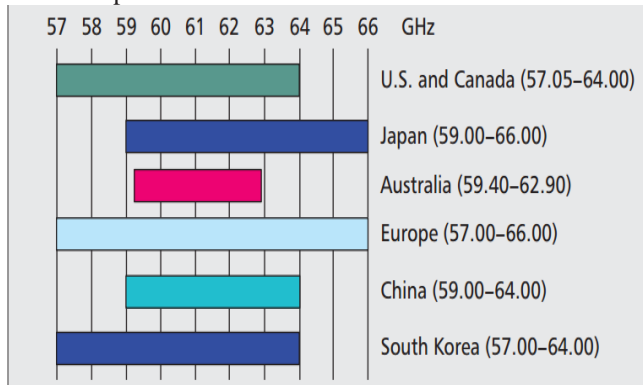

Figure 2.4: Frequency allocation for 60 GHz band in some countries

Other countries which have recently updated their 60 GHz regulations and have made the band available on a license exempt basis include the Philippines (2016), Malaysia (2015), South Africa (2015), Belgium (2014), New Zealand (2014), Brazil and Sweden (2014). In other countries the local regulators have not opened up unrestricted, unlicensed access to the 60 GHz band and this include India, Egypt, Iraq and Kenya. The huge unlicensed bandwidth allocated at the 60 GHz band is one of the largest bandwidths ever allocated. This huge bandwidth has presented great potential when it comes to flexibility and capacity, making the 60 GHz technology more attractive for the gigabit wireless applications. In comparison with the existing WPAN and WLAN systems [16], the 60 GHz regulation is seen to allow higher EIRP. From Table 2.2 we see examples of typical UWB, IEEE802.11 and 60 GHz systems operating near the Federal Communications Commission regulatory limit.

Implementing a powerful power amplifiers at 60GHz RF front end is very challenging and therefore the power output of the power amplifiers at this frequency is limited to 10dB. UWB systems on the other hand, expected to meet power spectrum mask restrictions of -41.3dBm per MHz based on Federal Communications Commission (FCC) regulations, offers limited EIRP of -10dBm for UWB system. This makes UWB system a low power and very short range system. In contrast, the 2.4/5.0 GHz power amplifier design is simpler and it can deliver higher power compared to 60 GHz system. Though, the limit of EIRP is confined to 30dBm because of the crowded ISM band. We can see that the 60GHz systems have an EIRP that is about 10dBm higher compared to that of IEEE802.11n and 45dBm higher than that of UWB system.

Table 2.2: Comparison of the typical implementation of 60 GHz, UWB and 802.11n systems

Technology	Frequency (GHz)	Power Amplifier output (dBm)	Antenna gain (dBi)	EIRP output (dBm)
60 GHz	57.0-66.0	10.0	25.0	35.0
UWB	3.1-10.6	-11.5	1.5	-10.0
IEEE 802.11n	2.4/5.0	22.0	3.0	25.0

To overcome the high path loss at 60 GHz more transmit power is necessary. There been high path loss at 60GHz, the

model system is only confined to operate at this frequency and render services for indoor environment and therefore making the effective interference levels less severe when compared to systems that operating at the congested 2.4/5.0 GHz bands. The availability of huge bandwidth for UWB and 60 GHz systems makes the system design simpler for these technologies. A system providing simpler implementation and low cost can be designed to deliver a Gbps transmission. Table 2.3 shows the required spectral efficiency by UWB, IEEE 802.11 and the 60 GHz systems in order to achieve the 1 Gbps transmission and also for the actual deployment of such systems. For typical 60 GHz system to achieve 1 Gbps, 0.4 bps/Hz is required hence making this system ideal candidate towards supporting applications of very high data rates using simple modulation. Although the UWB system requires 2 bps/Hz to obtain 1Gbps, when deployed at an operating range of 1 m the actual data rate is limited to 400 Mbps. For IEEE 802.11n systems to achieve the 1 Gbps will require 25 bps/Hz, hence extension beyond 1 Gbps of such system becomes unappealing when it comes to the implementation and cost. Also at 60 GHz, the huge path loss allows for the higher frequency reuse in an indoor environment leading to high throughput network. Multiple-antenna solutions are possible at the user terminal because of the 60 GHz compact size; this is difficult or even impossible at lower frequencies. Compared to 5 GHz systems, the 60 GHz systems has a form factor which is about 140 times smaller when compared to that 5 GHz systems and therefore can be integrated more easily into the consumer electronic products.

Table 2.3: Spectral efficiency comparisons for 60 GHz, UWB and IEEE 802.11n

Technology	Bandwidth (MHz)	Efficiency @ 1 Gbps (bps/Hz)	Target data rate (Mbps)	Efficiency required (bps/Hz)
60 GHz	2000	0.5	4000-10000	4.0
UWB	528	2.0	480-600	2.0
IEEE 802.11n	40-70	25.0	250-600	15.0

Despite the many advantages offered by the 60 GHz based communications, there are also a number of critical disadvantages which this band faces and needs to be addressed. From Fig. 2.5 shows the range and data rate requirements for a number of WPAN and WLAN systems. Since there is a need to distinguish between different standards for wider market exploitation there is a need of distinguishing between the different standards, therefore the standards which are relating to the 60 GHz are positioned for provision of rates in terms of gigabits and longer operating range in comparison to UWB systems but shorter compared to the IEEE 802.11n systems. The 60 GHz systems are typically designed for provision of data rates in terms of multi gigabit with an operating range that is below 20m for the support of various multimedia and home application. At such range and rate, the task of providing sufficient power margin for ensuring a communication link that is reliable for the 60 GHz will be non-trivial. For the high speed transmissions in the 60 GHz channel, the delay spread is also a limiting factor then can be resolved when beaming concept is applied.

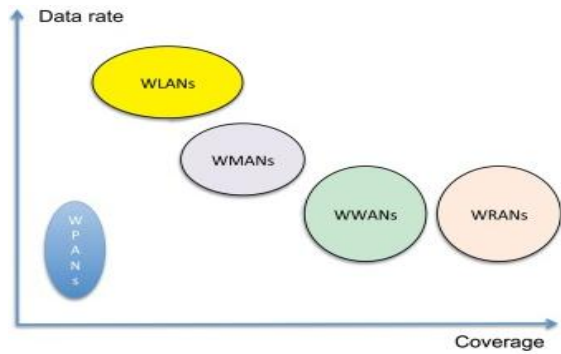

Figure 2.5: Rate and range for WLAN and WPAN standard

Whenever we have large values of the delay spread, the system complexity can easily increase beyond the limits that are practical for equalization.

2.5 Potential Applications of 60GHz services

With the availability of 7 GHz bandwidth allocation in most of countries, the radios at 60 GHz are now confined as technology enabler for the many transmission applications at gigabit rates that are not realized technically at lower frequency Industrial Scientific Medical band (ISM) band. The solutions possible with the proposed system model are:

- 1) Cables replacement or video streaming of the uncompressed high definition (HD) that is enabling the users to display the content wirelessly to a remote screen with a wired equivalent quality or experience. Uncompressed HD streaming is an asymmetric transmission with significantly different data flow in both uplink and downlink directions. This application also requires very low latency of tens of microseconds and very low bit error probability (down to 10^{-12}) to ensure high-quality video.
- 2) ‘Synch-and-go’ file transfer which enables file transfer of gigabytes in just a fraction of seconds.
- 3) Wireless docking stations which allow the connection of multiple-peripherals (including external monitor) without any need for the frequent plugging and unplugging;
- 4) Wireless Ethernet in gigabits permitting bidirectional multi gigabits Ethernet traffic;
- 5) Gaming which is ensuring low latency and high quality performance for exceptional user experience.

3. Implementation of Hybrid beam forming Technology

In HBF technique, the hardware complexity is minimized through configuring the transmitter using symbol-wise beam forming while subcarrier-wise beam forming is employed at the receiver for optimization of performance as shown in Fig. 3.5[12]. Both the symbol-wise and subcarrier-wise beam forming operations have been explained in sections 3.3.1 and 3.3.2 above. In this configuration the beam codebook is also used and therefore the effective SNR- $\gamma_{eff,hybrid}$ can be represented [1] [10][8] as

$$\gamma_{eff,hybrid} = \max_{c,c \in C} (-\beta) \ln \left(\frac{1}{N} \sum_{m=1}^N \exp \left(- \frac{|c^H R_m w_{opt}|^2}{\beta M_t M_r \sigma^2} \right) \right)$$

Where w_{opt} is the transmitter optimal beam steering vector attained from receiver vector

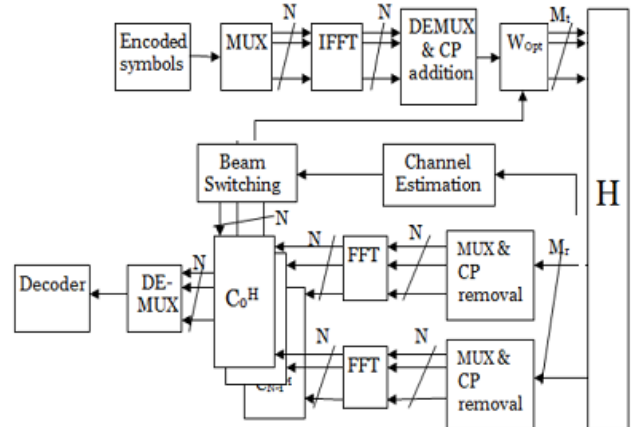

Figure 3.1: Hybrid beam forming

Fig.3.6 shows the hybrid beam forming program design. The hybrid beam forming design at the transmitter is just similar to that of the symbol-wise beam forming while at the receiver is similar to that of the subcarrier-wise beam forming which both have been explained earlier in this thesis report

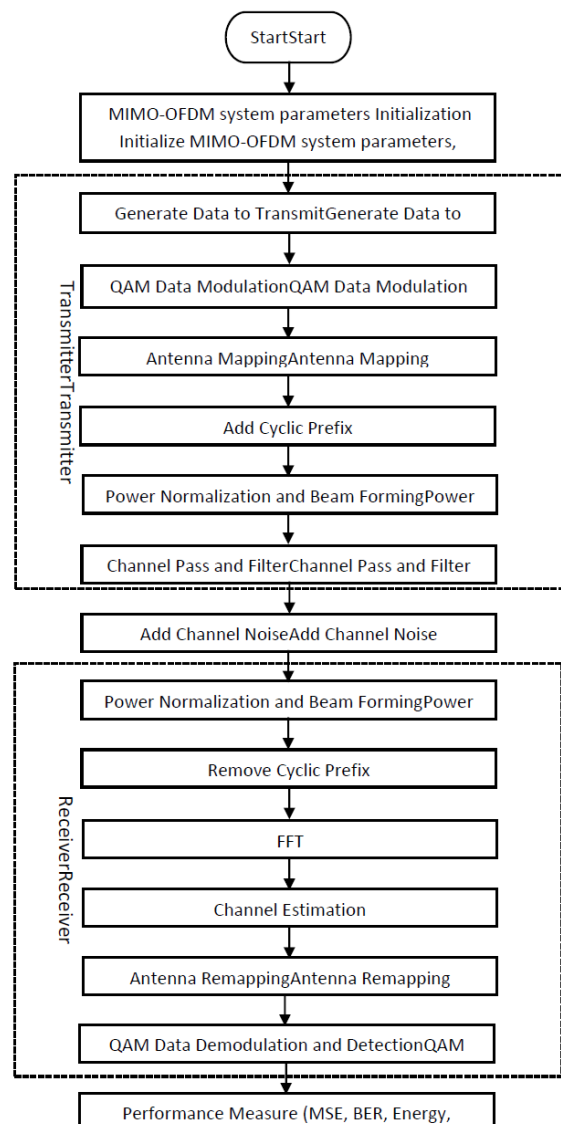

Figure 3.2: Hybrid beam forming program design

3.1 Beam forming Gain

The beam forming gain was evaluated using the 60 GHz channel models generated by isotropic antenna in a board room environment and LOS and NLOS scenarios are considered. The numbers of antenna elements at the transmitter and receiver are equal, with $M = M_t = M_r$. For the evaluation of beam forming performance [29] through the utilization of the parameters shown in Table.

Table 4.1: System parameters

Frequency	60 GHz
Bandwidth	2 GHz (59.12-60.88 GHz)
Modulation	64 QAM, OFDM
No. of Subcarriers	128, 256, 512
Transceiver distance	0-10m
Cyclic Prefix length	64-128 samples
Data Rate	0- 10 Gbps

The effective SNR of different beam forming techniques were calculated in comparison to the single antenna system (SISO) and using the formula and (SIMO)

$$G_{beamforming} = \frac{Y_{eff, beamforming}}{Y_{eff, SISO}} \quad (4.1)$$

Where $Y_{eff, beamforming}$ is defined as an effective SNR

while $Y_{eff, SISO}$ is obtained using equation (3.3). In Fig. 4.1, 60 GHz beam forming

Gain of different number of antenna elements with LOS for the three different beam forming schemes together with a bound is shown.

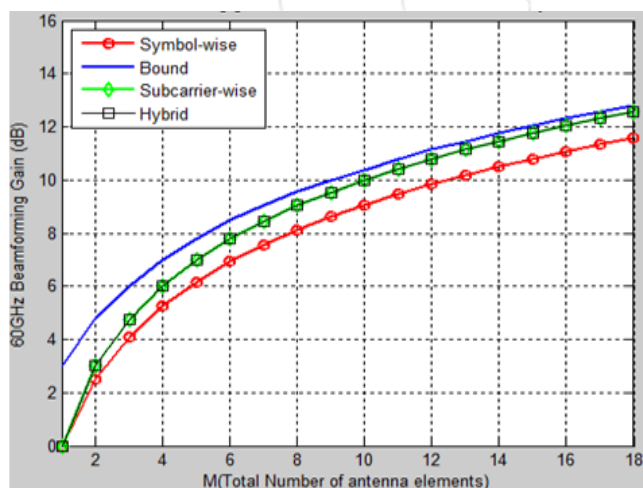

Figure 4.1: Beam forming gain vs Number of antennas in LOS

The bound is the theoretical beam forming gain which is achieved when MIMO channel is correlated totally where all the antenna elements are placed in one single point and only one single path exists between the receiver and transmitter. The bound gain can be calculated as [29],

$$G_{bound} [dB] = 10 \log_{10} (M_t M_r) \quad (4.2)$$

The beam forming gain of the three beam forming schemes is compared to the bound gain. In the case of LOS, it is observed that when the number of antenna elements is 6, the gap

between the bound and both subcarrier-wise BF and hybrid BF gain is approximately 1dB while the one between bound gain and symbol-wise BF gain is approximately 1.5 dB. It is also noteworthy that the gains for the subcarrier-wise beam forming and HBF are identical while the one for the symbol-wise beam forming is lower, this is due to the existence of the LOS where the channels of different links are more correlated, and also the smallness of the gain loss at the beam pattern intersection and hence the difference in performance is not significant. In Fig. 4.2, when the LOS does not exist, there is degradation on the beam forming performance.

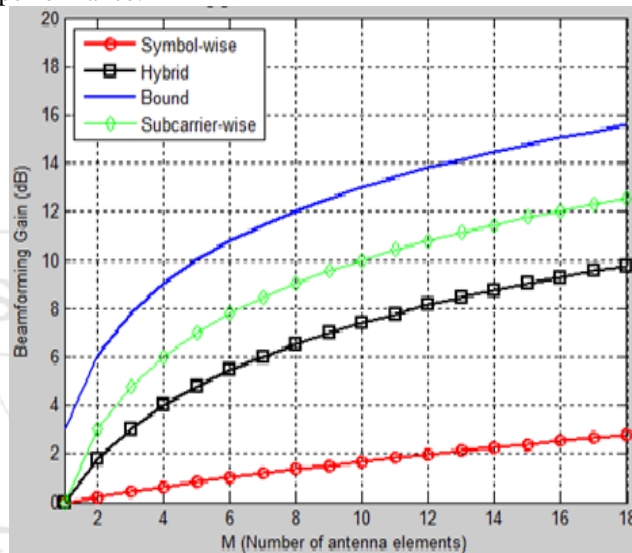

Figure 4.2: Beam forming gain vs Number of antennas in NLOS

It is observed that when the number of antenna elements is 6, the gap between the bound gain and subcarrier-wise beam forming gain is approximately 3 dB, the one between bound gain and hybrid BF gain is approximately 5 dB while between bound gain and symbol-wise beam forming gain is approximately 10 dB. From the results, it is observed that subcarrier-wise BF achieves performance levels closer to those of the theoretical beam forming gain, hybrid BF is the next and symbol-wise BF is the last one.

3.2 Bit Error Rate (BER) Performance

For verification of the beam forming systems numerical results, BER performance was obtained through simulation. As a reference, SISO system BER performance is plotted on the same graph with the assumption of perfect CSI. In this case an assumption of two antenna elements at both the receiver and transmitter sides is made.

Fig. 4.3 shows the BER performance for beam forming schemes with LOS scenario where BER versus SNR have been simulated for 64 QAM modulations while Fig. 4.4 shows the results in the case of NLOS scenario.

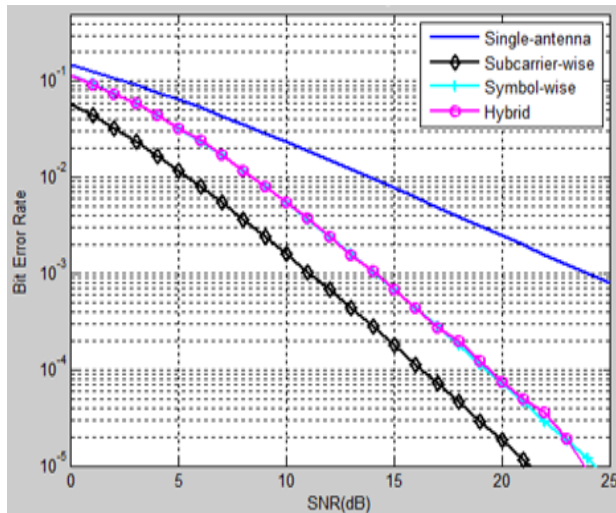

Figure 4.3: LOS BER performance comparison

In Fig.4.3, it is observed that in LOS scenario, a BER of 9×10^{-3} is achieved when the subcarrier-wise BF give a gain of 15 dB over single antenna system (BER of 3×10^{-2}), which is the accepted minimum SNR to establish a connection, while both hybrid and symbol-wise BF achieves 3×10^{-3} for the same gain.

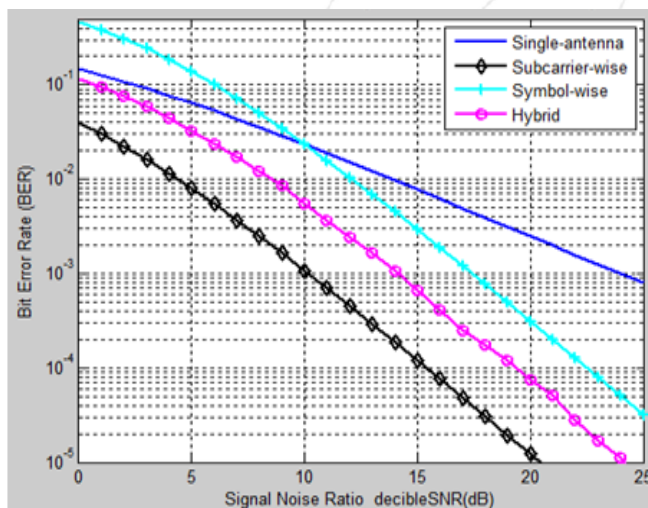

Figure 4.4: NLOS BER performance comparison

In Fig.4.4, the simulation results in the case of NLOS scenario shows that a BER of 10^{-4} is achieved when the subcarrier-wise BF gives a gain of 15 dB over single antenna system (BER of 2×10^{-2}) while hybrid BF achieves 3×10^{-3} for the same gain and symbol-wise achieves 8×10^{-2} .

4. Recommendations for Future Work

Implementation and fabrication of the developed beam forming system model in real world can be done to obtain practical results. This work can also be used in the recommendation of allocation of unlicensed 60 GHz spectrum in countries which have not exempted the licensing of this spectrum. This beam forming system model which utilizes OFDM based technology for short range communication for Wireless Personal Area Networks (WPAN) can also be implemented in the millimeter wave communication at Terahertz. The performance evaluation of

three types of beam forming techniques over the OFDM based Terahertz millimeter-wave WPAN can then be analyzed

References

- [1] O. Orhan, E. Erkip, and S. Rangan, "Low Power Analog-to-Digital Conversion in Millimeter Wave Systems: Impact of Resolution and Bandwidth on Performance," in *Proceedings of Information Theory and Applications (ITA) Workshop*, 2015.
- [2] J. Mo, A. Alkhateeb, S. Abu-Surra, and R. W. Heath Jr., "Achievable rates of hybrid architectures with few-bit ADC receivers," in *Proceedings of 20th International ITG Workshop on Smart Antennas*, Munich, Germany, March 2016, pp. 1–8
- [3] R. Fisher, "60 GHz WPAN Standardization within IEEE 802.15.3c", in *proceedings of International Symposium on Signals, Systems and Electronics, 2007. ISSSE '07*, Montreal, Canada, July 30 2007-August 2 2007, pp. 103-105.
- [4] IEEE Standard 802.15.3c: "Wireless Medium Access Control (MAC) and Physical Layer (PHY) Specifications for High Rate Wireless Personal Area Networks (WPANs), Amendment 2: Millimeter-wave-based Alternative Physical Layer Extension", IEEE, October 2009.
- [5] Z. Xiaoyi, A. Doufexi, T. Kocak, "A Performance Evaluation of 60 GHz MIMO Systems for IEEE 802.11ad WPANs", *IEEE 22nd International Symposium on G. W. Juette and L. E. Zeffanella*, "Radio noise currents in short sections on bundle conductors," presented at the IEEE Summer Power Meeting, Dallas, TX, June 22-27, 1990.
- [6] *Personal, Indoor and Mobile Radio Communications 2011*, Vol.1, Issue 3, pp: 950 – 954, 11-14 September 2011, Toronto, Canada
- [7] T. Nitché, C. Cordeiro, A. Flores, E. Knightly, E. Perahia and J. Widmer, "IEEE 802.11ad: Directional 60 GHz Communication for Multi-Gbps Wi-Fi," *IEEE Communication Magazine*, 52(12):132-141, December 2014.
- [8] Physical Layer Extension, 2009.
- [9] IEEE 802.11ad. Part 11: wireless LAN medium access control (MAC) and physical layer (PHY) specifications amendment 3: enhancements for very high throughput in the 60 GHz band, 2012.
- [10] M. Comiso, "Beam forming techniques for wireless communications in low-rank channels: analytical models and synthesis algorithms", *PhD Thesis, Universita degli Studi di Trieste*, Italy, 2003.
- [11] K. Ramachandran, R. Kokku, R. Mahindra and K. Maruhasi, "On the potential of fixed-beam 60 GHz network interfaces in mobile devices". Available: pam2011.gatech.edu/papers/pam2011--Ramachandran.pdf.
- [12] L. C. Pansana, "Transmit receive beamforming for 60 GHz indoor wireless communications", *MS thesis, Aalto University, Espoo*, Finland, August 2010.
- [13] S. Yoon, T. Jeon, and W. Lee, "Hybrid beam-forming and beam-switching for OFDM based wireless personal area networks", *IEEE Journal on Selected Areas in Communications*, 27(8), October 2009, pp. 1425-1432.